

WIRING DIAGRAM 1
(top of chassis)

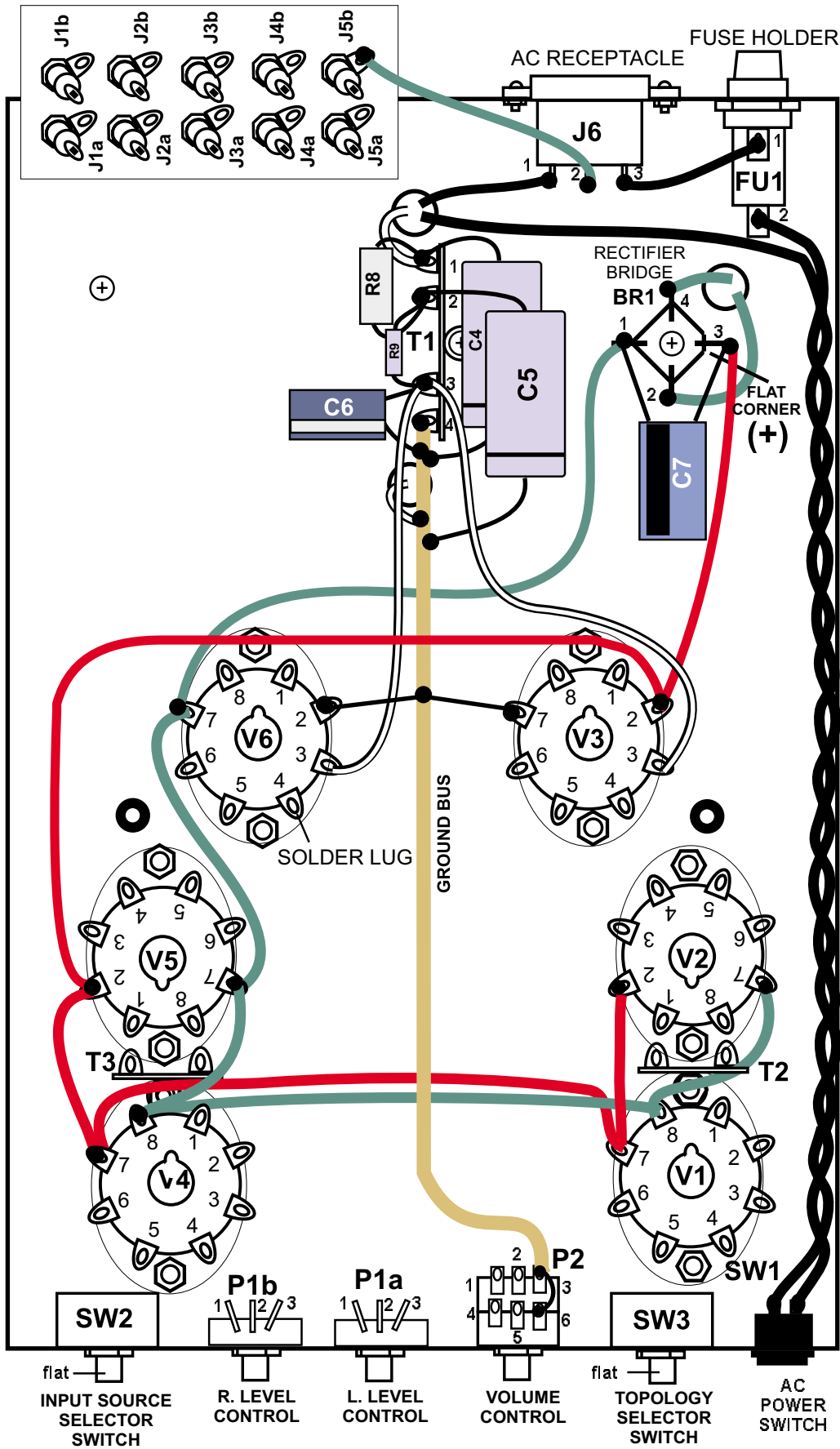

WIRING DIAGRAM 2
(underside of chassis)

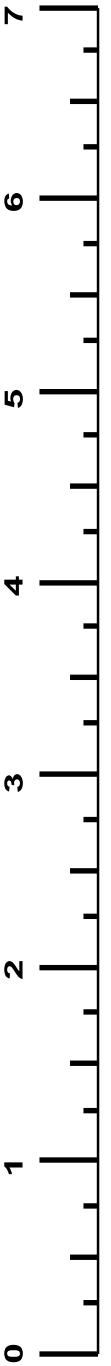

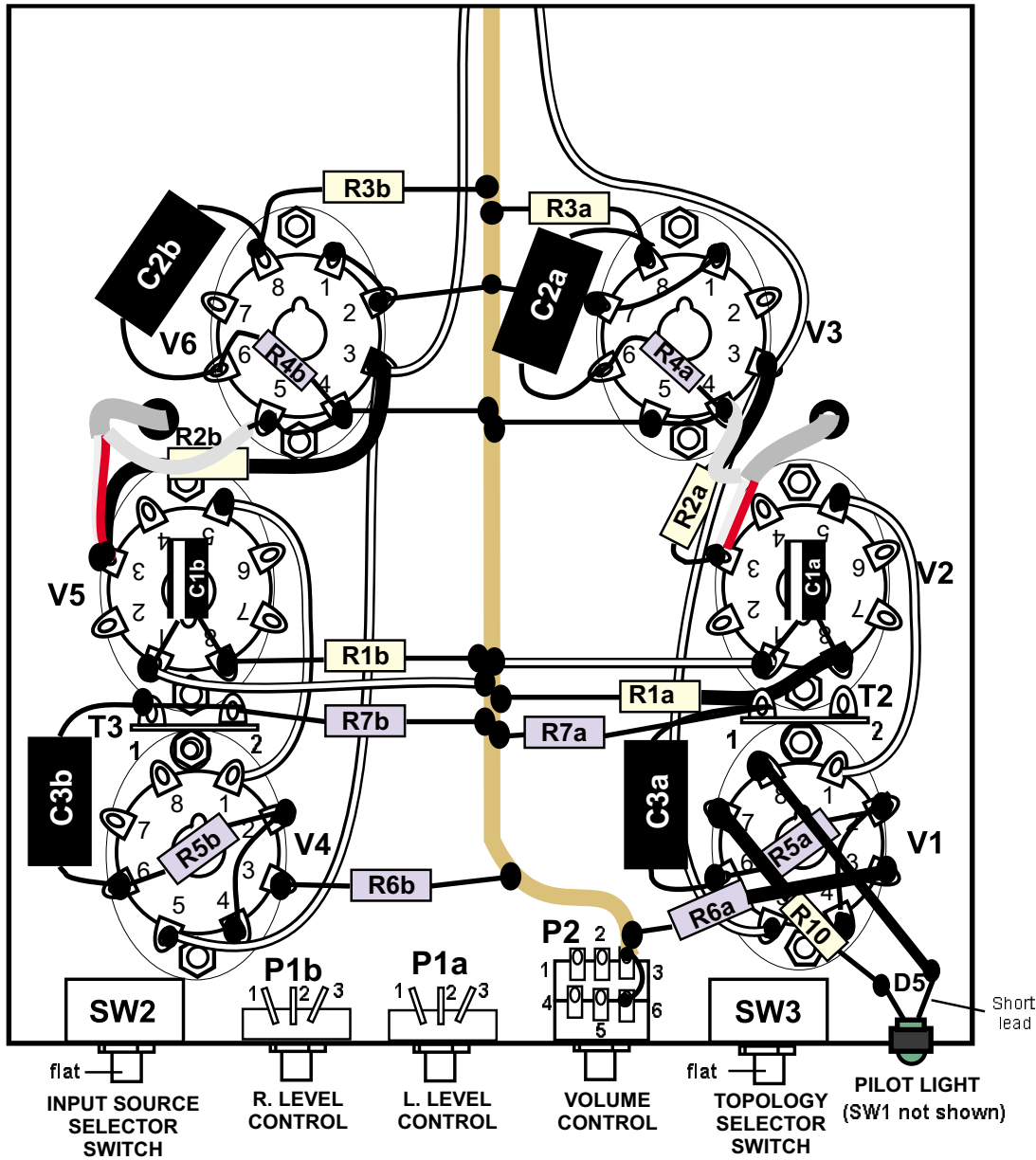

WIRING DIAGRAM 3
(underside of chassis)

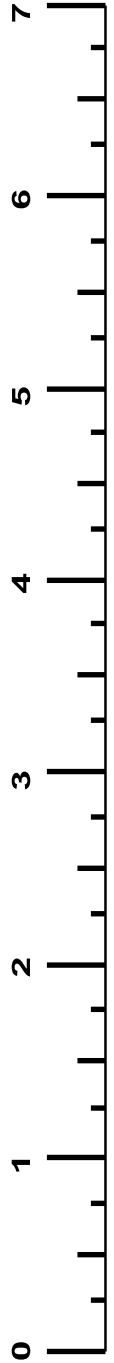
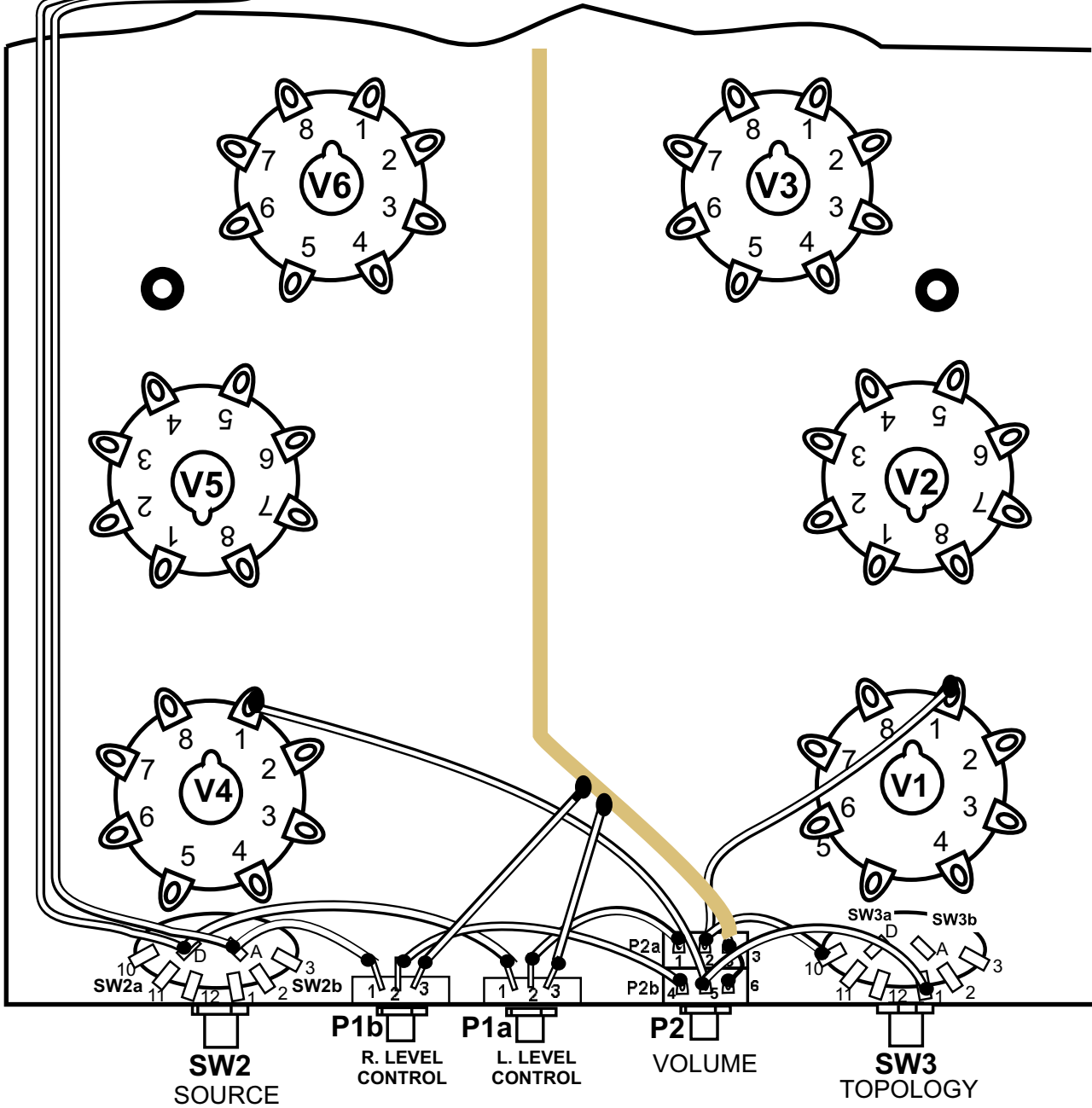
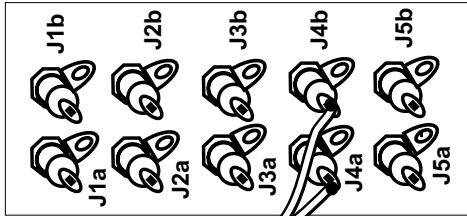

WIRING DIAGRAM 4A
(record output)

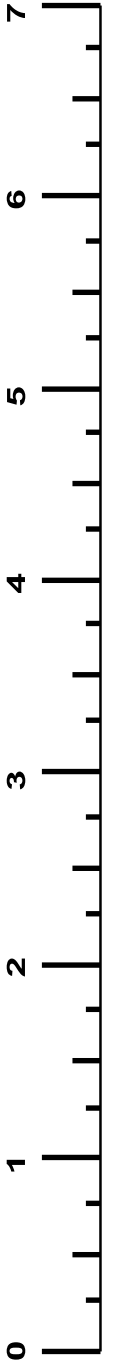
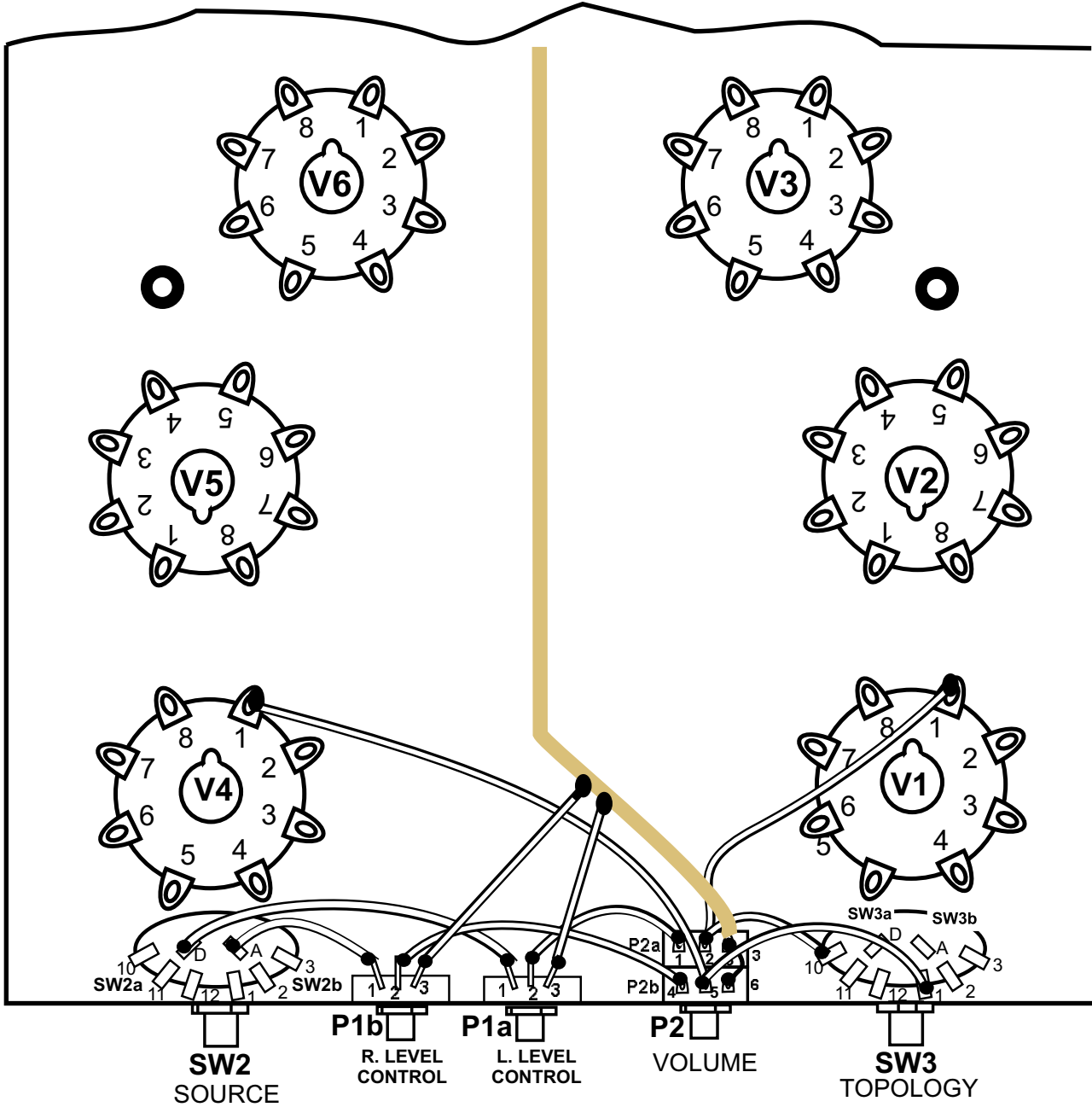
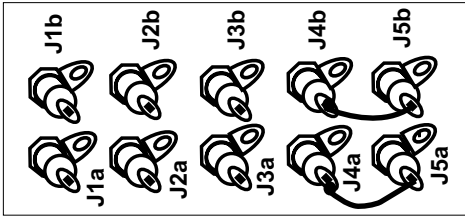

WIRING DIAGRAM 4B
(dual outputs)

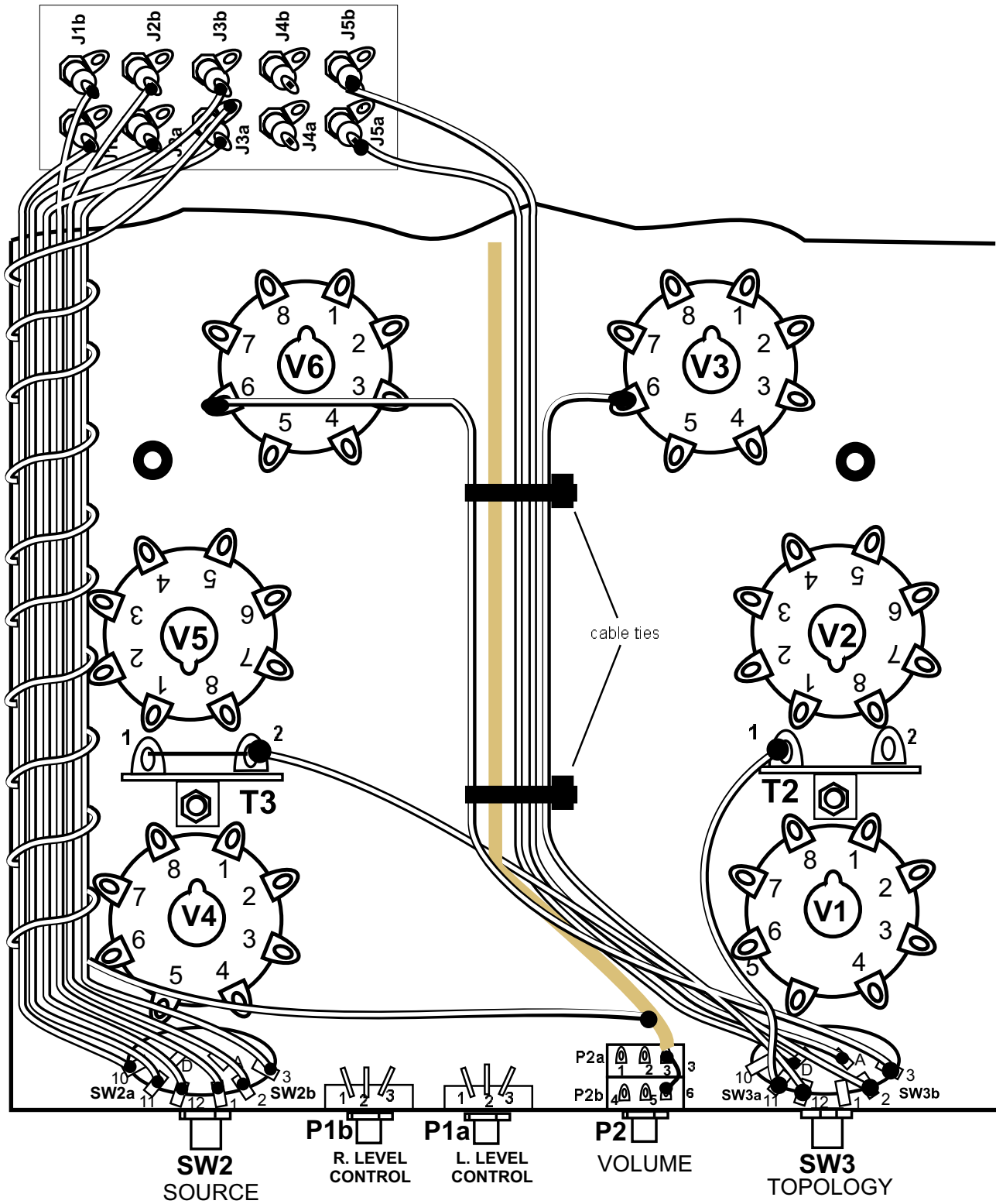

WIRING DIAGRAM 5